

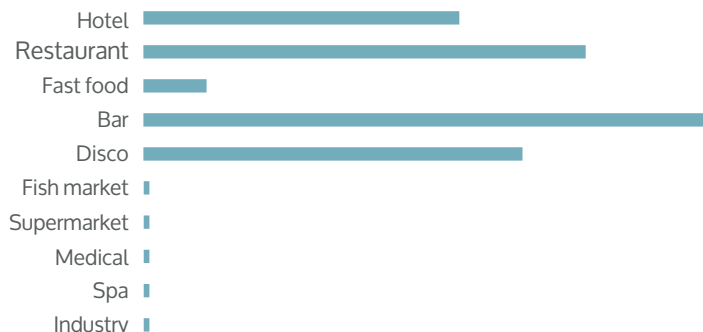

ECF 26 NG

Produttore di ghiaccio con contenitore incorporato - Sistema a palette - Produzione giornaliera fino a 30 kg
Self-contained ice maker - Paddle system - Daily production up to 30 kg



Caratteristiche Features

- **Cubetto cavo 20 gr**
Hollow cube 20 gr
- **Struttura esterna AISI 304, Scotch Brite**
External structure AISI 304, Scotch Brite
- **Griglie laterali per una migliore aereazione interna**
Side grillers for better inside ventilation
- **Pannelli removibili**
Removable panels
- **Sistema di funzionamento elettromeccanico**
Electromechanical functioning
- **Condensazione ad aria o ad acqua**
Air or water cooling system
- **Voltaggio standard e voltaggi speciali**
Standard and special voltages
- **Pulizia semplificata grazie alle superfici arrotondate**
Easy cleaning thanks to rounded surfaces
- **RoHS free**
RoHS free
- **Isolamento contenitore interno privo di HCFC**
Internal bin insulation HCFC free
- **Materiali bacinella acqua certificati FDA**
Water basin materials FDA approved
- **Interruttore On/Off**
On/Off switch

Garanzia 1 Anno / 1 Year Warranty

soggetta a limitazioni / subject to limitations

Produzione 24h / Production 24h

T. Aria / Air temp.		T. Acqua / Water temp.		kg	lbs
10°C	50° F	7° C	45° F	30	66
21° C	70° F	15° C	60° F	20	44

Cubetti disponibili per questo modello Available ice cube size

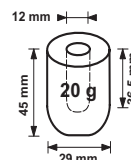

Certificazioni disponibili per questo modello / Certification available for this model





CUBETTO CAVO
HOLLOW CUBE

ECF 26 NG

Produttore di ghiaccio con contenitore incorporato - Sistema a palette - Produzione giornaliera fino a 30 kg
Self-contained ice maker - Paddle system - Daily production up to 30 kg

Condizioni d'installazione Working conditions

Posizione: **Interna**
Location: **Indoor**

	Min	Max
T. Ambiente / Ambient temp.	+10° C / +50° F	+43° C / +110° F
T. Acqua / Water temp.	+3° C / +37° F	+32° C / +90° F
Voltaggio / Voltege	-10%	+10%
Pres. acqua ingresso / Water inlet pressure	1 bar (14 psi)	6 bar (84 psi)

Performance / Performances

	Temperatura acqua / Water temperature	Temperatura acqua / Water temperature					
		7° C	45° F	15° C	60° F	21° C	70° F
Temperatura aria Air temperature	10° C	30 kg					
	50° F		66 lbs				
	21° C			20 kg			
	70° F				44 lbs		
	32° C					16 kg	
	90° F						35 lbs

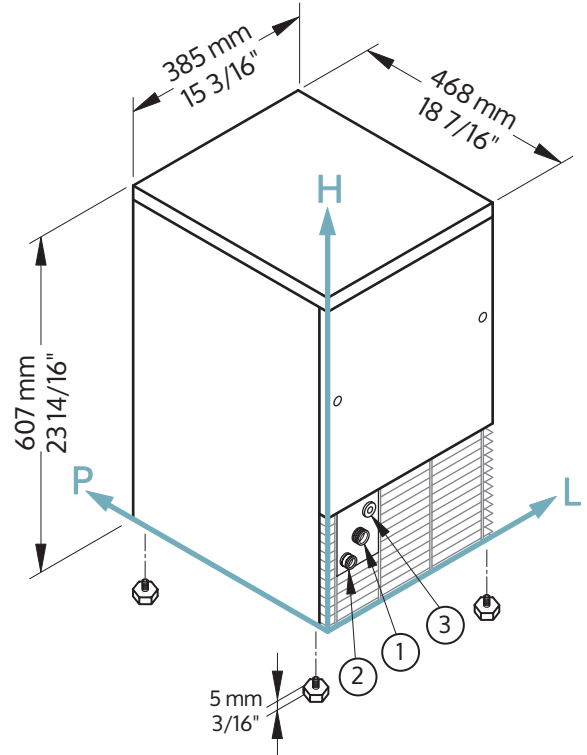

Connessioni / Connections

Le misure sono riferite all'angolo del retro in basso a sinistra (L-H-Ø) / Alle measures are referred to the rear bottom-left corner (L-H-Ø)

- ① Ingresso acqua / Water in: 111 mm / 4 6/16" - 175 mm / 6 14/16" - 3/4"
- ② Scarico acqua / Water out: 49 mm / 115/16" - 130 mm / 5 2/16" - 24 mm / 15/16"
- ③ Connessione elettrica / Electrical connection: 156 mm / 6 2/16" - 211 mm / 8 5/16"

Informazioni tecniche / Technical information

Prod. in 24h / Production 24h	20 kg / 44 lbs	Consumo d'acqua / Water consumption	A: 3 l/kg - 35,9 gal/100 lbs
Capacità contenitore, fino a / Storage capacity, up to	4 kg / 9 lbs		W: 17 l/kg - 203,7 gal/100 lbs
Condensazione / Cooling system	A - W	Dimensioni (L-P-H mm)	385 - 468 - 607
Tipo di cubetto / Kind of cube	20g	Sizes (L-P-H in)	15 3/16 - 18 7/16 - 23 14/16
Refrigerante / Refrigerant	R290	Dimensioni imballo (L-P-H mm)	440 - 520 - 800
Voltaggio standard / Standard voltage	220-240 V ~ 50 Hz	Sizes with pack (L-P-H in)	17 5/16 - 20 8/16 - 31 8/16
Potenza media assorbita / Average power cons.	300 W	Peso netto / Net weight	36 kg / 79 lbs
Fusibile / Fuse	10 A	Peso lordo / Gross weight	42 kg / 93 lbs
Finitura / Finish	AINI 304 Stainless Steel, scotch brite		

Tutti i dati tecnici sono da considerarsi validi alle seguenti condizioni:
All the technical information must be considered at the following condition:

Dimensioni esclusi i piedini / Size without feet
Cubetto standard (20g) / Standard cube (20g)
Temperatura ambiente +21° C / Ambient temperature +21° C
Temperatura acqua +15° C / Water temperature +15° C
Potenza media assorbita a +43° C (Voltaggio standard) / Average power consumption at +43° C (standard voltage)

I modelli ed i dati riportati possono essere soggetti a modifiche senza alcun preavviso
Models and specifications are subject to change without notice

Rev. 00 - Issued March 2020